

Teelicht Hülle Tealight Cup

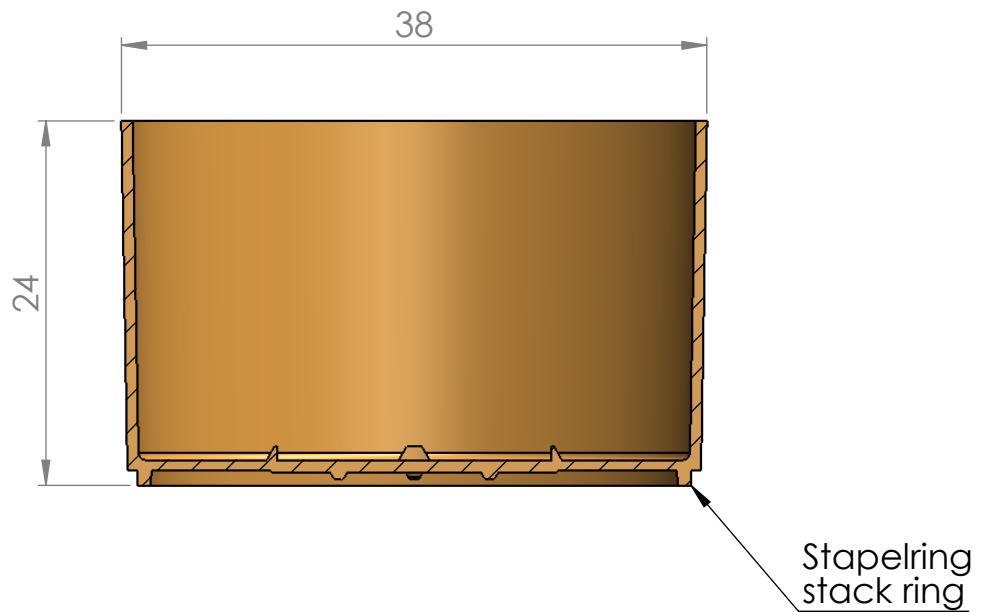

$$V_F \sim 21,6\text{cm}^3$$

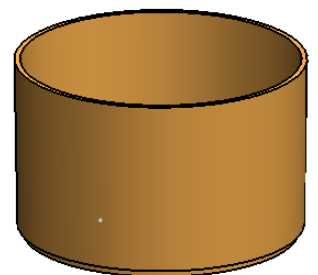

2:1 A4	111	EG-PLASTIC SPRITZGUSSTECHNIK
Index A	Material: PET +PC	Fa. EG-Plastic GmbH Dockweiler Str. 18 54522 Dreis-Brück Tel.: +49 (0) 6595 9299-0 Fax: +49 (0) 6595 9299-18 info@eg-plastic.de
2015-05-12	www.eg-plastic.de Copyright EG-Plastic GmbH	DIN EN ISO 9001